

Netzanschluss

Achtung, beim Anschluss auf die örtlichen EVU-Vorschriften und Netzformen achten!

a						-1T4,-1T5,-1T6		09.10.19	Pfip	Datum	13.03.14	Netz, Generator	EM-6R3	VISSMANN Viessmann Kraft-Wärme-Kopplung GmbH 86899 Landsberg, Emmy-Noether-Str.3 Tel.08191/9279-0 Fax.9279-23	Vitobloc 200 EM-6/15 R3		Anlage	=
b						-1Q1:23,24		17.10.19	Pfip	Bearb.	Spensberger						Ort	+ 5840066 DE
Zustand						Änderung	Datum	Name	Norm	BHKW	Urspr.				Ers. f.	Serien-Nr.	Modul-Nr.	Blatt
															von	46		

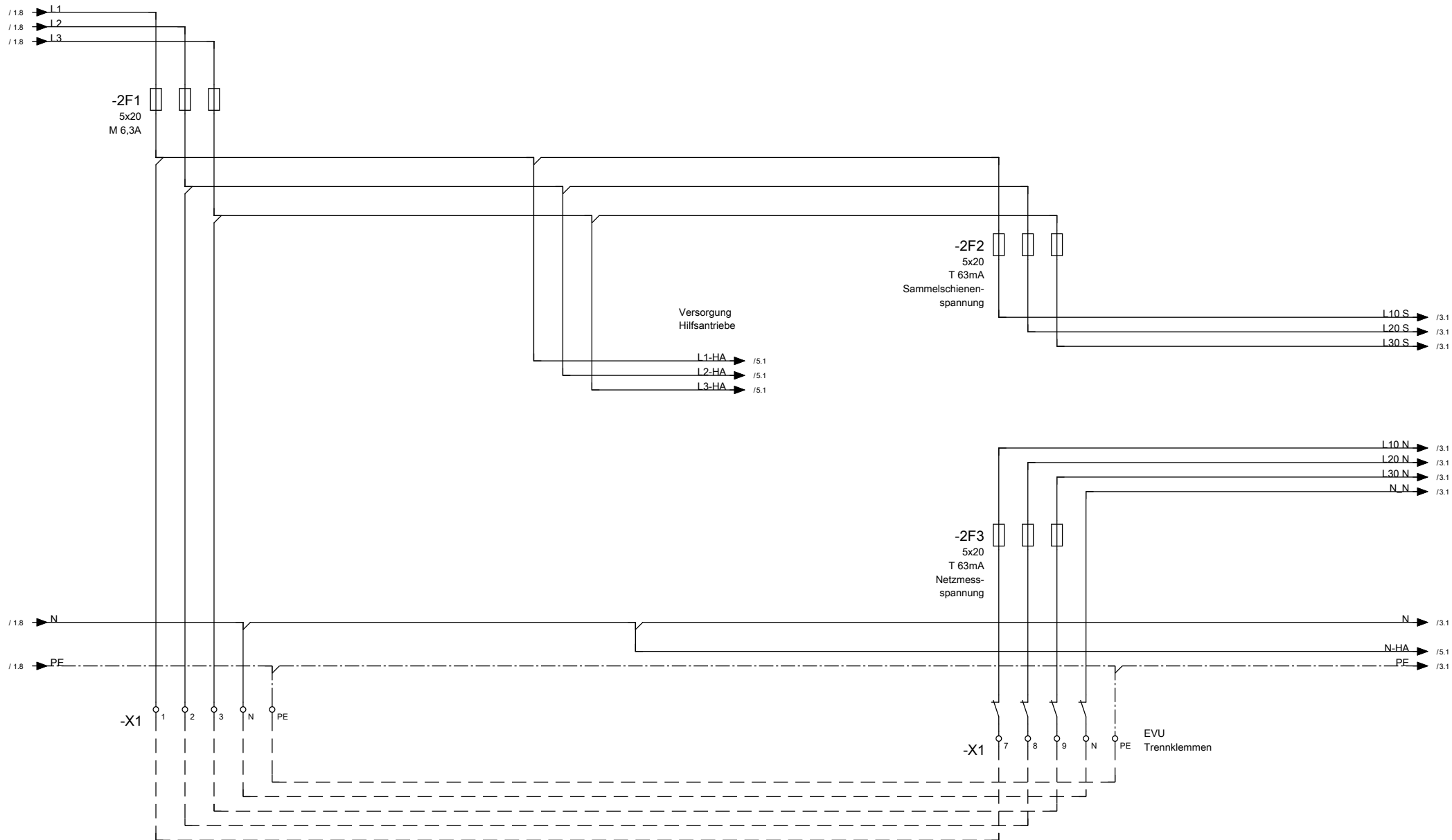

1										3										
					Datum 13.03.14		EM-6R3		Viessmann Kraft-Wärme-Kopplung GmbH 86899 Landsberg, Emmy-Noether-Str.3 Tel.08191/9279-0 Fax.9279-23		Vitobloc 200 EM-6/15 R3		Anlage =		Ort + 5840066 DE		Blatt 2		von 46	
					Bearb. Spensberger		Versorgung Hilfsantriebe													
					Gepr. R.Schmid															
Zustand					Änderung		Datum		Name		Norm		BHKW		Urspr.		Ers. f.			

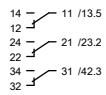
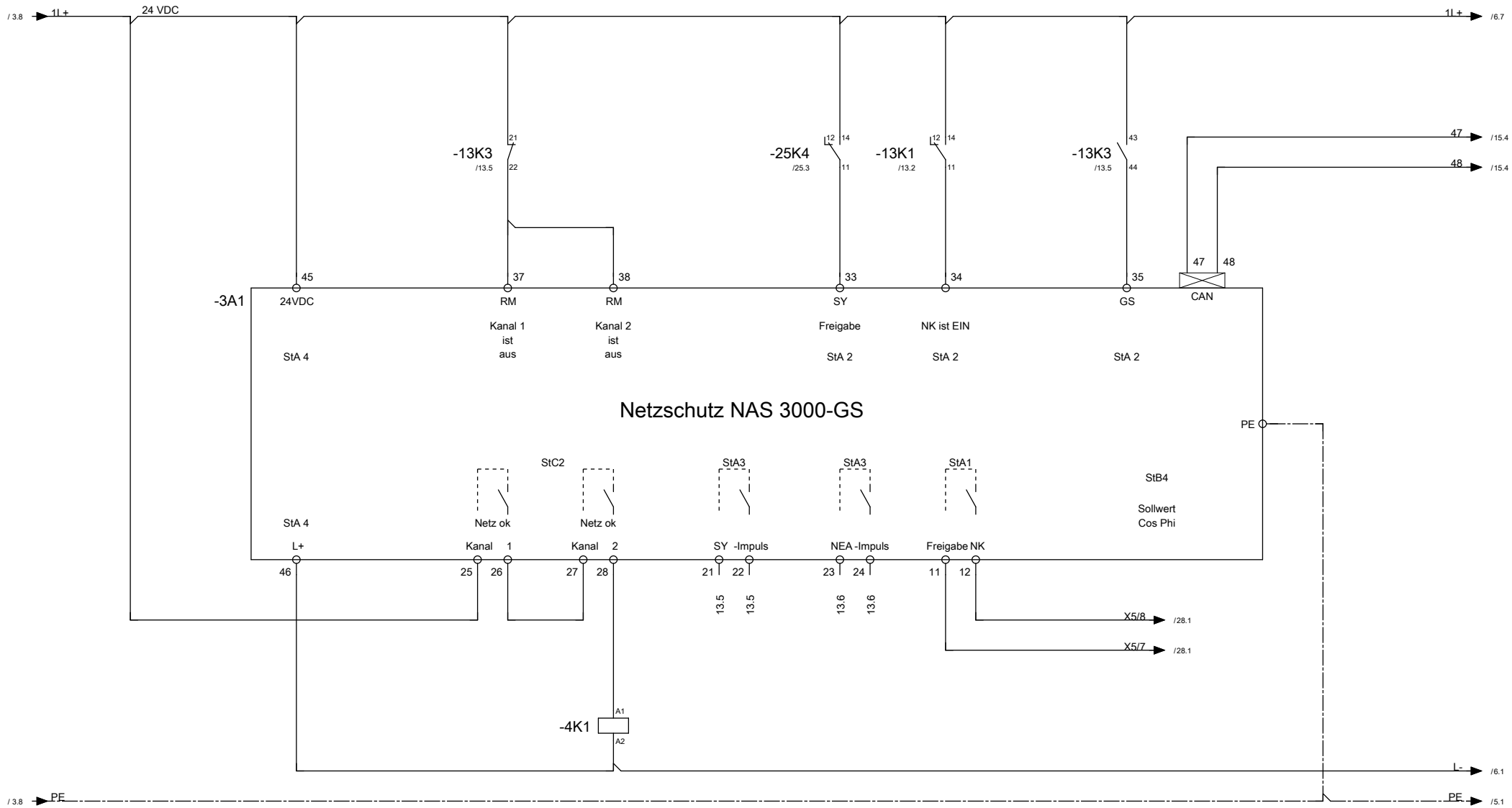

Netz ok

		Datum	13.03.14						Anlage	=	
		Bearb.	Spensberger		Netzschutz		EM-6R3		Ort	+ 5840066 DE	
		Gepr.	R.Schmid						Vitobloc 200 EM-6/15 R3		
Zustand	Änderung	Datum	Name	Norm	BHKW	Urspr.	Ers. f.	Viessmann Kraft-Wärme-Kopplung GmbH 86899 Landsberg, Emmy-Noether-Str.3 Tel.08191/9279-0 Fax.9279-23		Serien-Nr. Modul-Nr.	Blatt von
											4 46

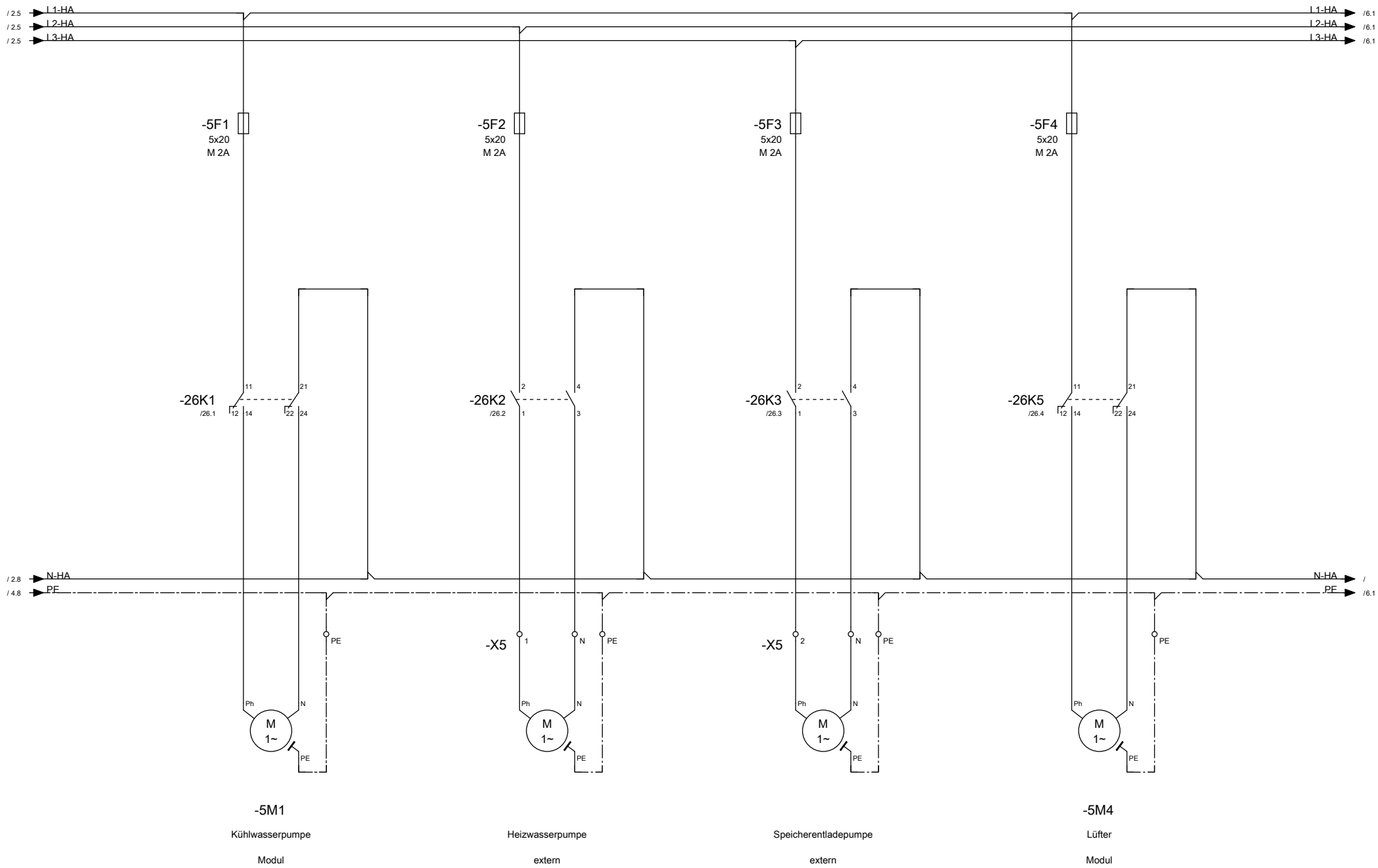

4						6						
E	26K2+3->2S	27.10.14	SpnB	Datum	13.03.14	Sicherungsabgänge Hilfsantriebe	EM-6R3	VIEMANN Viessmann Kraft-Wärme-Kopplung GmbH 86899 Landsberg, Emmy-Noether-Str.3 Tel.08191/9279-0 Fax.9279-23	Vitobloc 200 EM-6/15 R3		Anlage	=
G	-5X1, -5F5 gelöscht	07.07.15	SpnB	Bearb.	Spensberger				Ort	+ 5840066 DE		
				Gepr.	R.Schmid				Serien-Nr.			Blatt
Zustand	Änderung	Datum	Name	Norm	BHKW	Urspr.	Ers. f.	Modul-Nr.			von	46

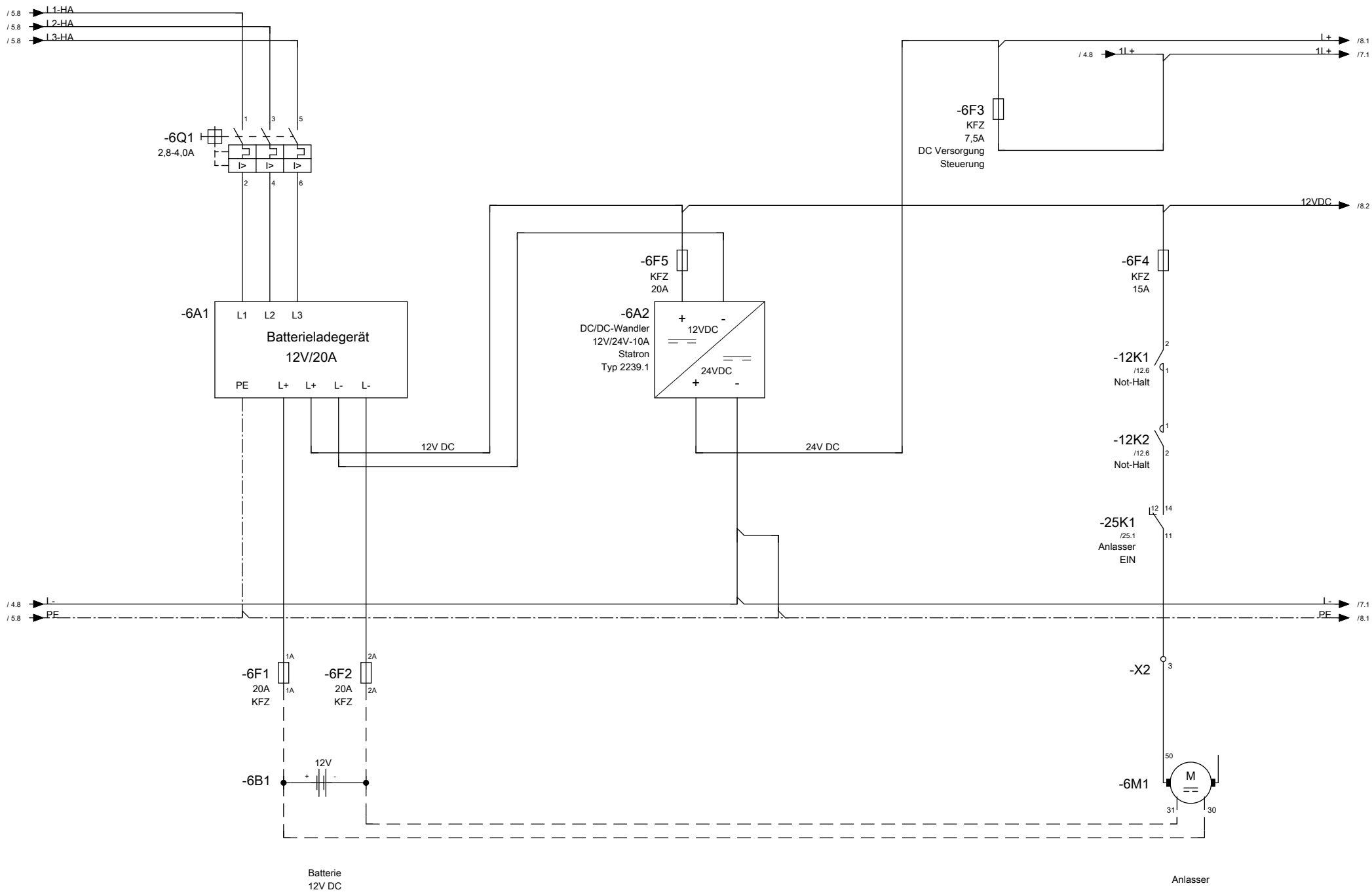

a	-6F5	02.10.19	Pfip	Datum	13.03.14	Batterie, Anlasser	EM-6R3	VIEMANN Viessmann Kraft-Wärme-Kopplung GmbH 86899 Landsberg, Emmy-Noether-Str.3 Tel.08191/9279-0 Fax.9279-23	Vitobloc 200 EM-6/15 R3	Anlage	=
				Bearb.	Spensberger					Ort	+ 5840066 DE
Zustand	Änderung	Datum	Name	Norm	BHKW				Urspr.	Ers. f.	Serien-Nr.
										von	46

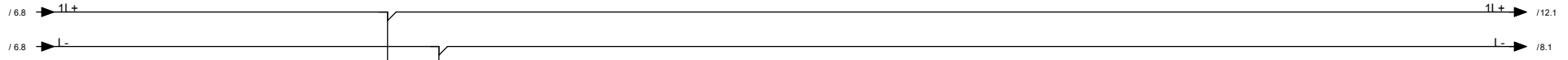

/43.6 CosPhi+
/43.6 CosPhi-

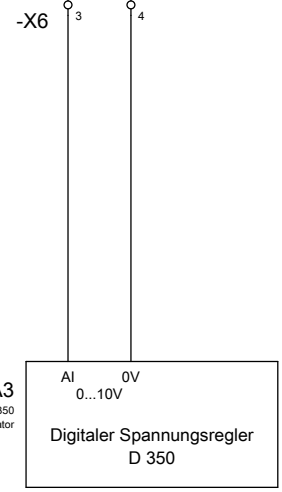
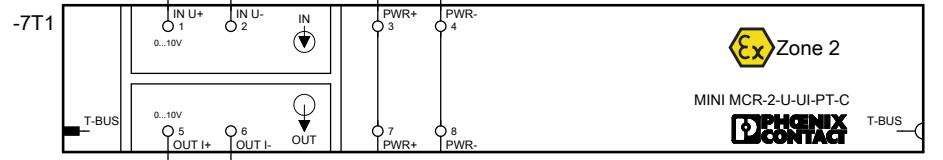

Bei Spannungsregler R483
Trennverstärker Eingang und Ausgang
auf -5..+5V umstellen
Dipschalter S1 und S2

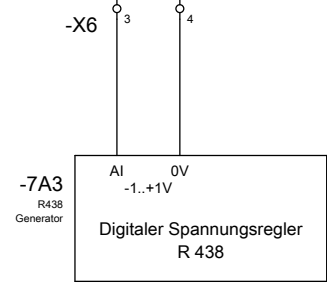
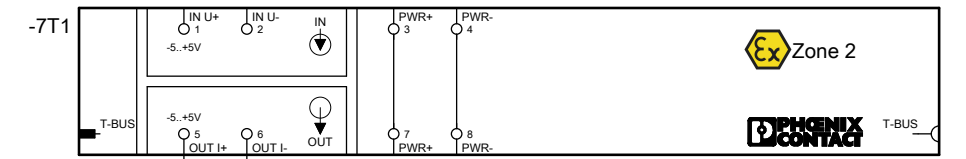

Sollwert
cos Phi

		Datum 14.08.19		Trennverstärker Spannungsregler		EM-6R3		Viessmann Kraft-Wärme-Kopplung GmbH 86899 Landsberg, Emmy-Noether-Str.3 Tel.08191/9279-0 Fax.9279-23		Anlage =		Blatt 7	
		Bearb. Pfeleiderer						Vitibloc 200 EM-6/15 R3		Ort =		von 46	
		Gepr.								Serien-Nr.		5840066 DE	
Zustand		Änderung		Datum		Name		Norm		BHKW		Urspr. Ers. f.	

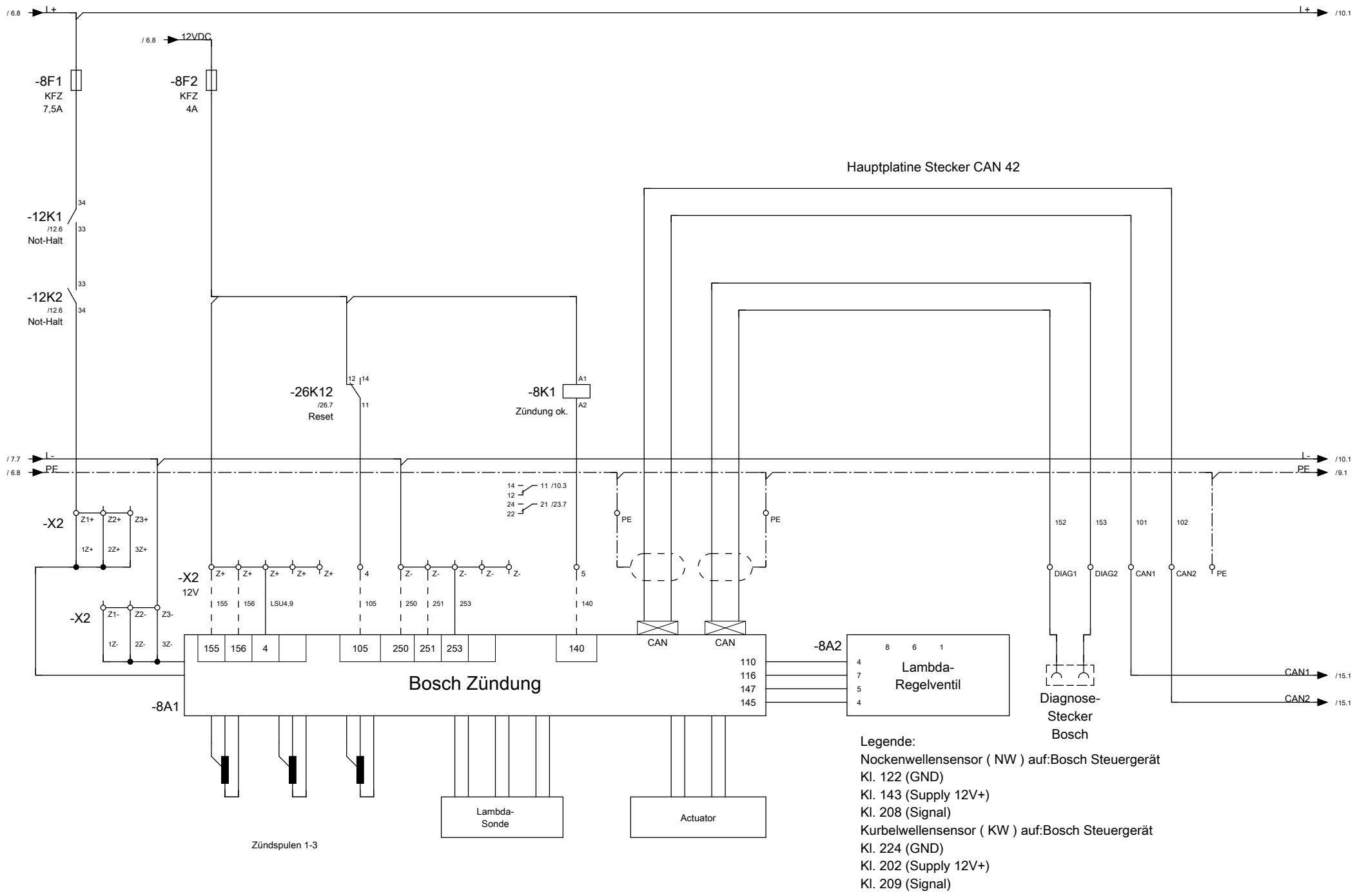

Zustand		Änderung	Datum	Name	Norm	BHKW	Urspr.	Ers. f.	EM-6R3	Viessmann Kraft-Wärme-Kopplung GmbH 86899 Landsberg, Emmy-Noether-Str.3 Tel.08191/9279-0 Fax.9279-23	Vitobloc 200 EM-6/15 R3	Anlage = Ort + 5840066 DE	Blatt 8 von 46
-X2 Kl. 6		-X2 Kl. L-	Datum 13.03.14	Bearb. Spensberger	Bosch-Zündung								
			Gepr. R.Schmid										

-9A1

BHKW-Basis-Steuerung GASMODUL - Stecker 51

Gasdruck min.		Gasdruck max.		Gemischdruck max.		Übertemperatur Motor 1		STB		SDB		Druckdose Dichttest V1-V2		Reserve	

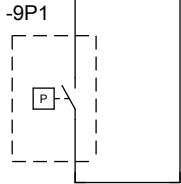
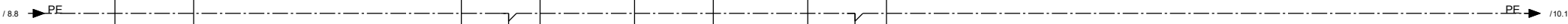

Gasdruck min.

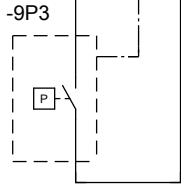

Gemischdruck max. (Option)

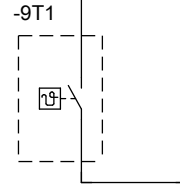

Temp. max.
Motorraum (Klixon 70°C)

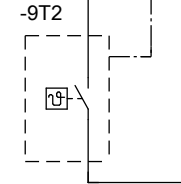

STB Kühlwasser

				Datum	13.03.14	BHKW-Basis-Steuerung Gasmodul - Stecker 51		EM-6R3		VIESMANN Viessmann Kraft-Wärme-Kopplung GmbH 86899 Landsberg, Emmy-Noether-Str.3 Tel.08191/9279-0 Fax.9279-23		Anlage =		Ort + 5840066 DE		Blatt 9 von 46	
				Bearb.	Spensberger							Vitobloc 200 EM-6/15 R3					
				Gepr.	R.Schmid							Serien-Nr. Modul-Nr.					
Zustand	Änderung	Datum	Name	Norm	BHKW	Urspr.	Ers. f.										

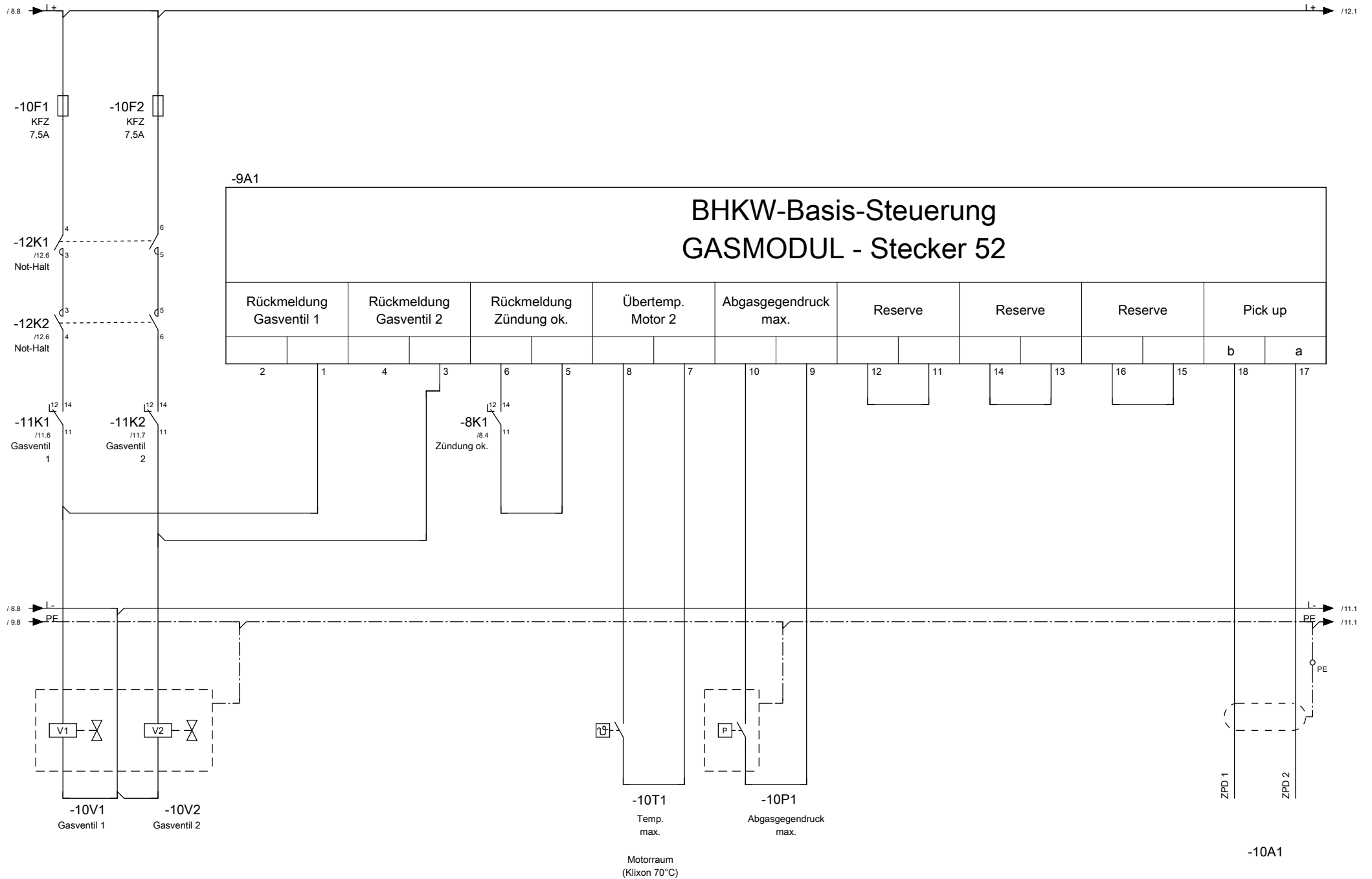

		Datum	13.03.14								Anlage	=	
		Bearb.	Spensberger		BHKW-Basis-Steuerung		EM-6R3		Viessmann		Ort	+ 5840066 DE	
		Gepr.	R.Schmid		Gasmodul - Stecker 52				Viessmann Kraft-Wärme-Kopplung GmbH				
									86899 Landsberg, Emmy-Noether-Str.3				
									Tel.08191/9279-0 Fax.9279-23				
Zustand	Änderung	Datum	Name	Norm	BHKW	Urspr.	Ers. f.			Serien-Nr.	Blatt 10		
										Modul-Nr.	von 46		

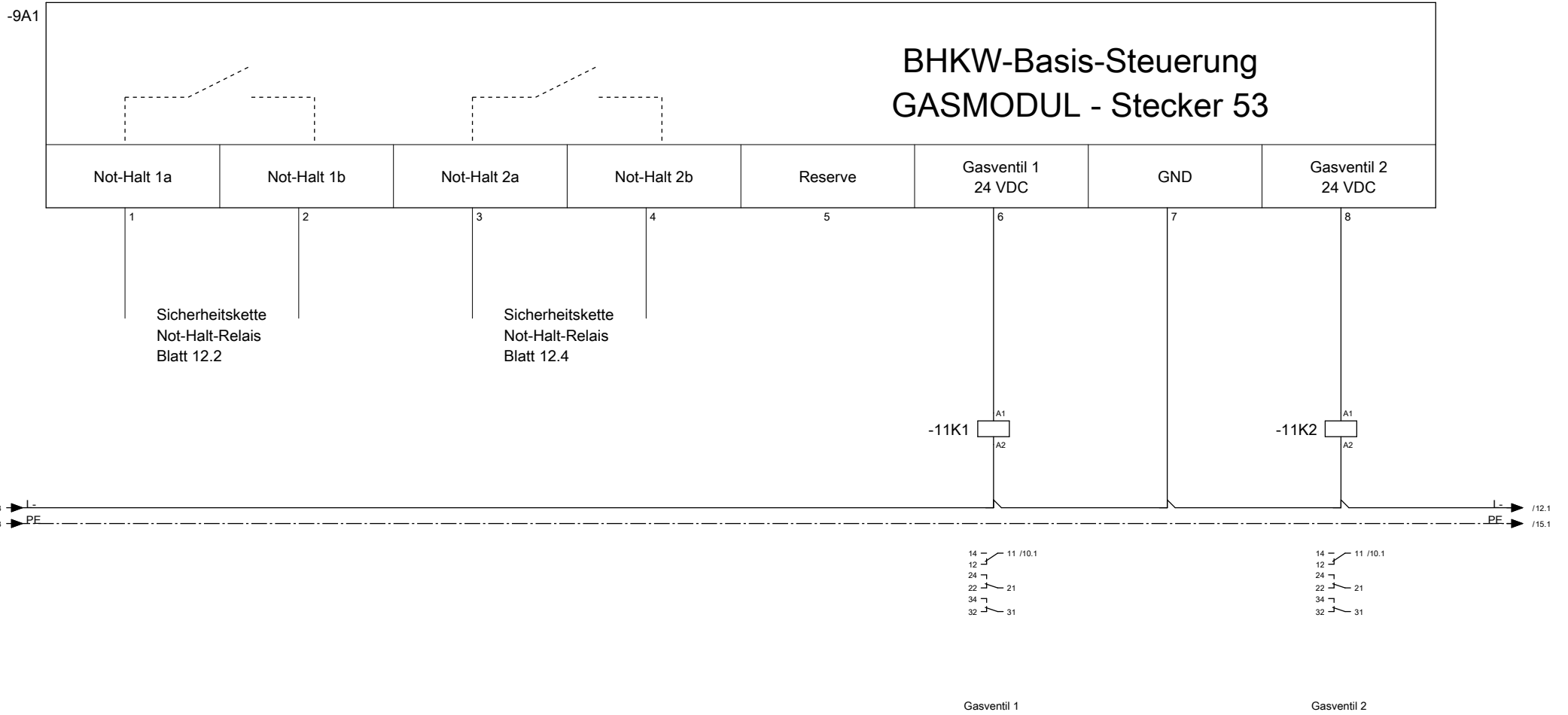

		Datum	13.03.14		BHKW-Basis-Steuerung Gasmodul - Stecker 53		EM-6R3		 Viessmann Kraft-Wärme-Kopplung GmbH 86899 Landsberg, Emmy-Noether-Str.3 Tel.08191/9279-0 Fax.9279-23		Anlage		=			
		Bearb.	Spensberger								Vitobloc 200 EM-6/15 R3		Ort		+ 5840066 DE	
		Gepr.	R.Schmid								Serien-Nr.		Modul-Nr.		Blatt 11 von 46	
Zustand	Änderung	Datum	Name	Norm	BHKW	Urspr.	Ers. f.									

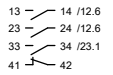
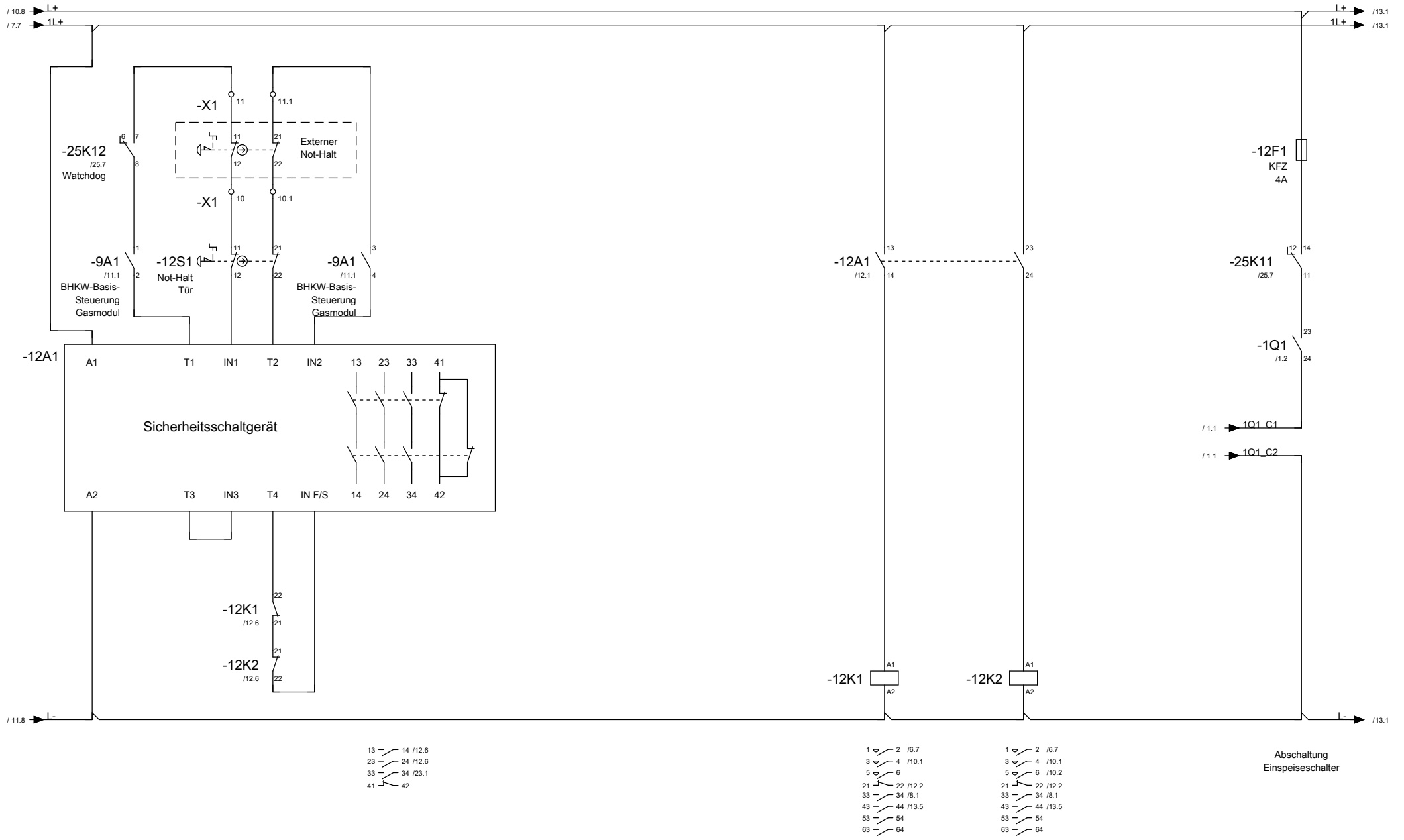

Not-Halt

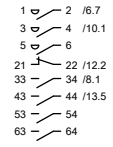

Not-Halt

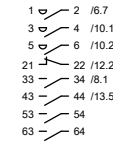

Not-Halt

Abschaltung
Einspeiseschalter

a	-1Q1:23,24	17.10.19	Pfip	Datum	13.03.14	Not-Halt	EM-6R3	 Viessmann Kraft-Wärme-Kopplung GmbH 86899 Landsberg, Emmy-Noether-Str.3 Tel.08191/9279-0 Fax.9279-23	Vitobloc 200 EM-6/15 R3		Anlage	=
				Bearb.	Spensberger				Ort	+ 5840066 DE		
				Gepr.	R.Schmid				Serien-Nr.		Blatt	12
Zustand	Änderung	Datum	Name	Norm	BHKW	Urspr.	Ers. f.	Modul-Nr.		von	46	

				Datum	13.03.14	Leerblatt		EM-6R3	 Viessmann Kraft-Wärme-Kopplung GmbH 86899 Landsberg, Emmy-Noether-Str.3 Tel.08191/9279-0 Fax.9279-23	Vitobloc 200 EM-6/15 R3		Anlage	=
				Bearb.	Spensberger					Ort	+ 5840066 DE		
				Gepr.	R.Schmid					Serien-Nr.		Blatt	14
Zustand	Änderung	Datum	Name	Norm	BHKW	Urspr.	Ers. f.			Modul-Nr.		von	46

-15A2

BHKW-Basis-Steuerung - Stecker 11

Ölstand min.		Ölstand max.		Ölnachfüllsensor		Kühlwasserdruck min.		Reserve		Reserve		Reserve		Reserve	
						+ -									

2 1 4 3 6 5 8 7 10 9 12 11 14 13 16 15

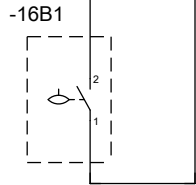

Ölstand min.

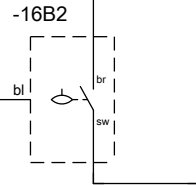

Kühlwasserdruck min.

/ 15.8

/ 19.1

					Datum	13.03.14		BHKW-Basis-Steuerung Stecker 11-DE1 Digitale Eingänge			EM-6R3		VIESMANN Viessmann Kraft-Wärme-Kopplung GmbH 86899 Landsberg, Emmy-Noether-Str.3 Tel.08191/9279-0 Fax.9279-23		Vitobloc 200 EM-6/15 R3		Anlage	=
					Bearb.	Spensberger									Ort	+ 5840066 DE		
					Gepr.	R.Schmid									Serien-Nr.			Blatt
Zustand	Änderung	Datum	Name	Norm	BHKW	Urspr.	Ers. f.			Modul-Nr.			von	46				

-15A2

BHKW-Basis-Steuerung - Stecker 12

Reserve		Reserve		Reserve		Reserve		Reserve		Reserve		Startposition Gas A		Startposition Gas B	
2	1	4	3	6	5	8	7	10	9	12	11	14	13	16	15

				Datum	13.03.14	BHKW-Basis-Steuerung Stecker 12-DE2 Digitale Eingänge		EM-6R3	VIESMANN Viessmann Kraft-Wärme-Kopplung GmbH 86899 Landsberg, Emmy-Noether-Str.3 Tel.08191/9279-0 Fax.9279-23	Vitobloc 200 EM-6/15 R3		Anlage	=
				Bearb.	Spensberger					Ort	+ 5840066 DE		
				Gepr.	R.Schmid					Serien-Nr.		Blatt	17
Zustand	Änderung	Datum	Name	Norm	BHKW	Urspr.	Ers. f.			Modul-Nr.		von	46

-15A2

BHKW-Basis-Steuerung - Stecker 13

Lambdaregelventil AUF		Lambdaregelventil ZU		Ölnachfüllventil		Reserve		Reserve		Reserve		Reserve		Reserve	
1	2	3	4	5	6	+	-	9	10	11	12	13	14	15	16

				Datum	13.03.14	BHKW-Basis-Steuerung Stecker 13-DA1 Digitale Ausgänge		EM-6R3	VIESMANN Viessmann Kraft-Wärme-Kopplung GmbH 86899 Landsberg, Emmy-Noether-Str.3 Tel.08191/9279-0 Fax.9279-23	Vitobloc 200 EM-6/15 R3		Anlage	=
				Bearb.	Spensberger					Ort	+ 5840066 DE		
				Gepr.	R.Schmid					Serien-Nr.		Blatt	18
Zustand	Änderung	Datum	Name	Norm	BHKW	Urspr.	Ers. f.			Modul-Nr.		von	46

-15A2

BHKW-Basis-Steuerung - Stecker 14

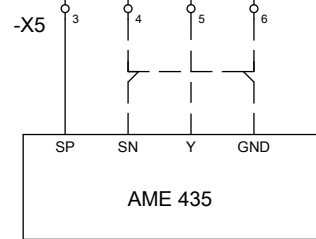
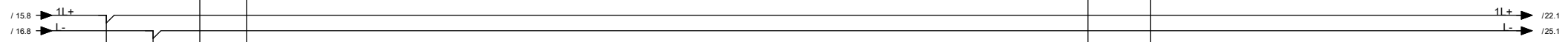
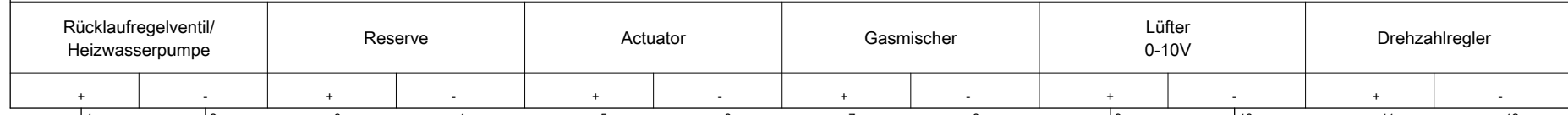

Rücklaufregelventil
oder Heizwasserpumpe
0..10V

Reserve

(Option)
Actuator
Direktansteuerung
Reserve

(Option)
Gasmischer
0..10V
Reserve

Lüfter
0-10V

(Option)
Drehzahlregler
Sollwert
Reserve

					Datum	13.03.14	BHKW-Basis-Steuerung Stecker 14-AA1 Analoge Ausgänge			EM-6R3	 Viessmann Kraft-Wärme-Kopplung GmbH 86899 Landsberg, Emmy-Noether-Str.3 Tel.08191/9279-0 Fax.9279-23	Vitobloc 200 EM-6/15 R3		Anlage	=
					Bearb.	Spensberger						Ort	+ 5840066 DE		
					Gepr.	R.Schmid						Serien-Nr.		Blatt	19
Zustand	Änderung	Datum	Name	Norm	BHKW	Urspr.	Ers. f.			Modul-Nr.		von	46		

-15A2

BHKW-Basis-Steuerung - Stecker 15

LSU1	LSU2	LSU3	LSU4	LSU5	LSU6
------	------	------	------	------	------

				Datum	13.03.14	BHKW-Basis-Steuerung LSU		EM-6R3		Vitobloc 200 EM-6/15 R3	Anlage	=
				Bearb.	Spensberger					Ort	+ 5840066 DE	
				Gepr.	R.Schmid					Serien-Nr.	Blatt	20
Zustand	Änderung	Datum	Name	Norm	BHKW	Urspr.	Ers. f.		Viessmann Kraft-Wärme-Kopplung GmbH 86899 Landsberg, Emmy-Noether-Str.3 Tel.08191/9279-0 Fax.9279-23	Modul-Nr.	von	46

-15A2

BHKW-Basis-Steuerung - Stecker 16

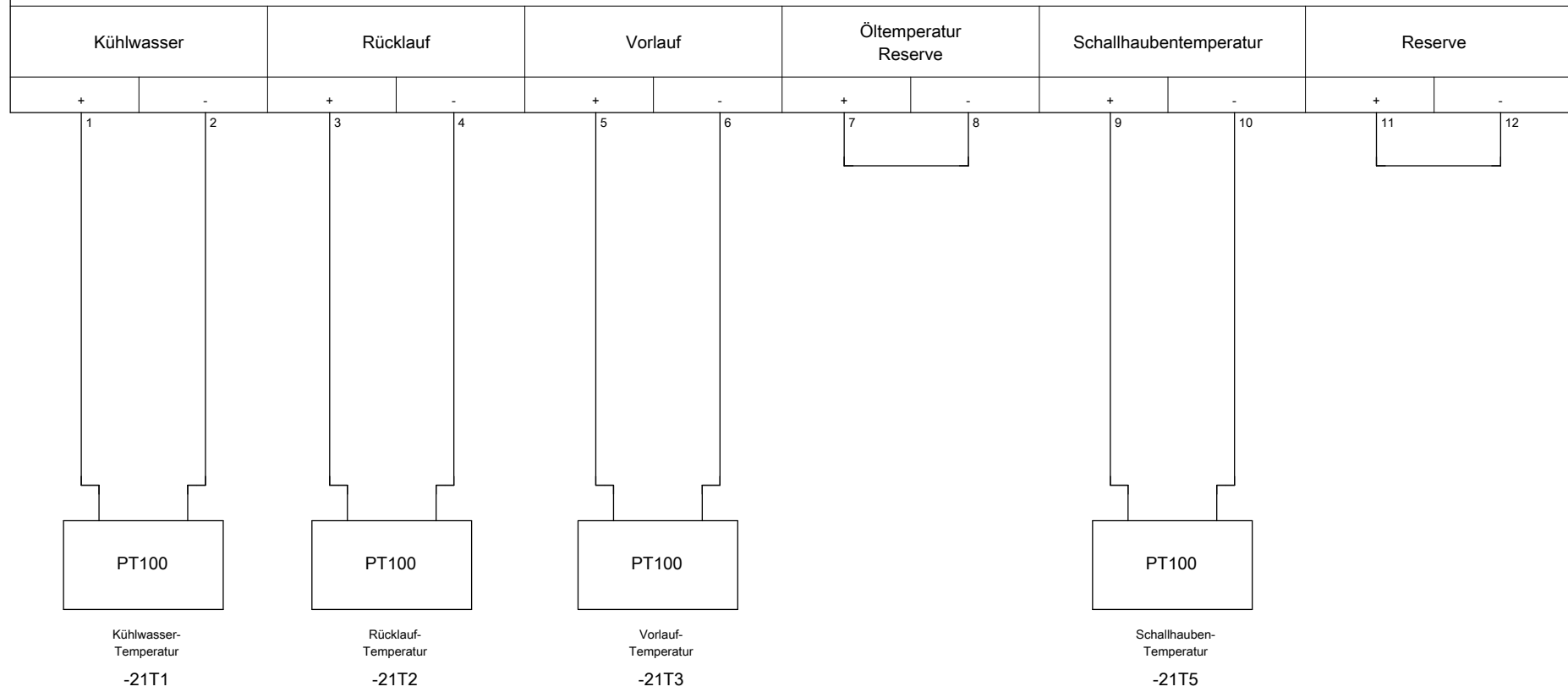

				Datum 13.03.14		BHKW-Basis-Steuerung Stecker 16-AE1 Analoge Eingänge		EM-6R3		 Viessmann Kraft-Wärme-Kopplung GmbH 86899 Landsberg, Emmy-Noether-Str.3 Tel.08191/9279-0 Fax.9279-23		Anlage =		Ort + 5840066 DE			
				Bearb. Spensberger								Vitobloc 200 EM-6/15 R3		Serien-Nr.		Blatt 21	
				Gepr. R.Schmid								Modul-Nr.		von 46			
Zustand	Änderung	Datum	Name	Norm	BHKW	Urspr.	Ers. f.										

-15A2

BHKW-Basis-Steuerung - Stecker 17

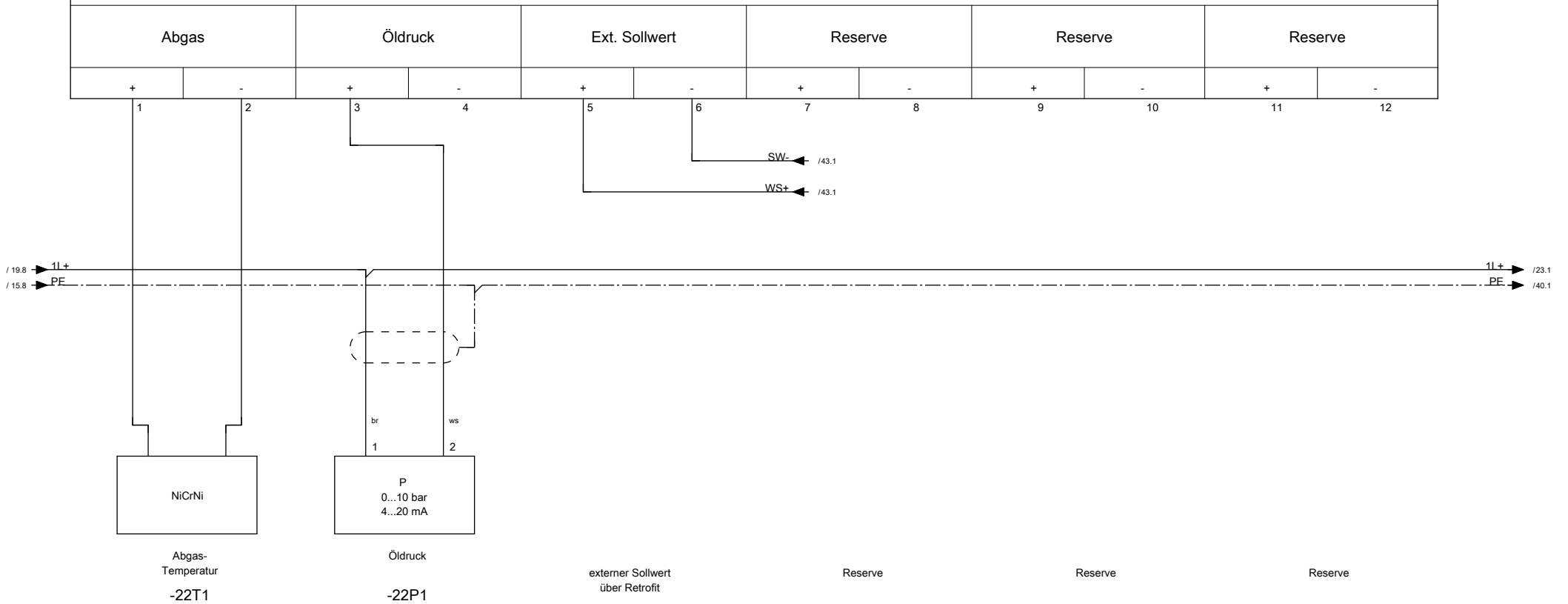

J	Schirm	23.9.16	Klaj	Datum	13.03.14	BHKW-Basis-Steuerung Stecker 17-AE2 Analoge Eingänge	EM-6R3	VIESMANN Viessmann Kraft-Wärme-Kopplung GmbH 86899 Landsberg, Emmy-Noether-Str.3 Tel.08191/9279-0 Fax.9279-23	Vitobloc 200 EM-6/15 R3	Anlage	=
				Bearb.	Spensberger				Ort	+ 5840066 DE	
				Gepr.	R.Schmid				Serien-Nr.		Blatt
Zustand	Änderung	Datum	Name	Norm	BHKW	Urspr.	Ers. f.	Modul-Nr.		von	46

-15A2

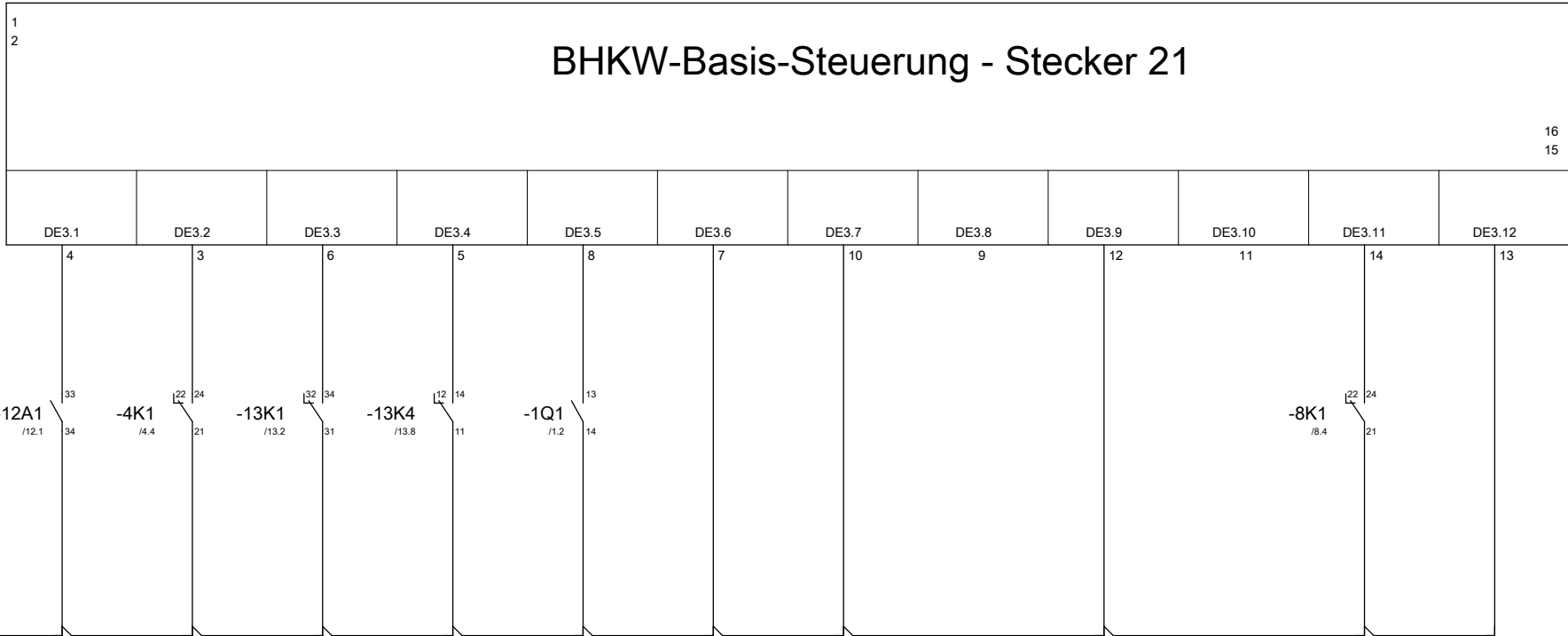

Not-Halt Netz ok. NK-Schalter ist EIN Generator ist EIN -1Q1 gestört KW-Pumpe gestört HW-Pumpe gestört Reserve Lüfter 1 gestört Reserve Zündung ok. Dichttest

				Datum	13.03.14	BHKW-Basis-Steuerung Stecker 21-DE3 Digitale Eingänge Schaltschrank		EM-6R3		Vitobloc 200 EM-6/15 R3		Anlage	=
				Bearb.	Spensberger					Ort	+ 5840066 DE		
				Gepr.	R.Schmid					Serien-Nr.		Blatt	23
Zustand	Änderung	Datum	Name	Norm	BHKW	Urspr.	Ers. f.	Viessmann Kraft-Wärme-Kopplung GmbH 86899 Landsberg, Emmy-Noether-Str.3 Tel.08191/9279-0 Fax.9279-23		Modul-Nr.		von	46

-15A1

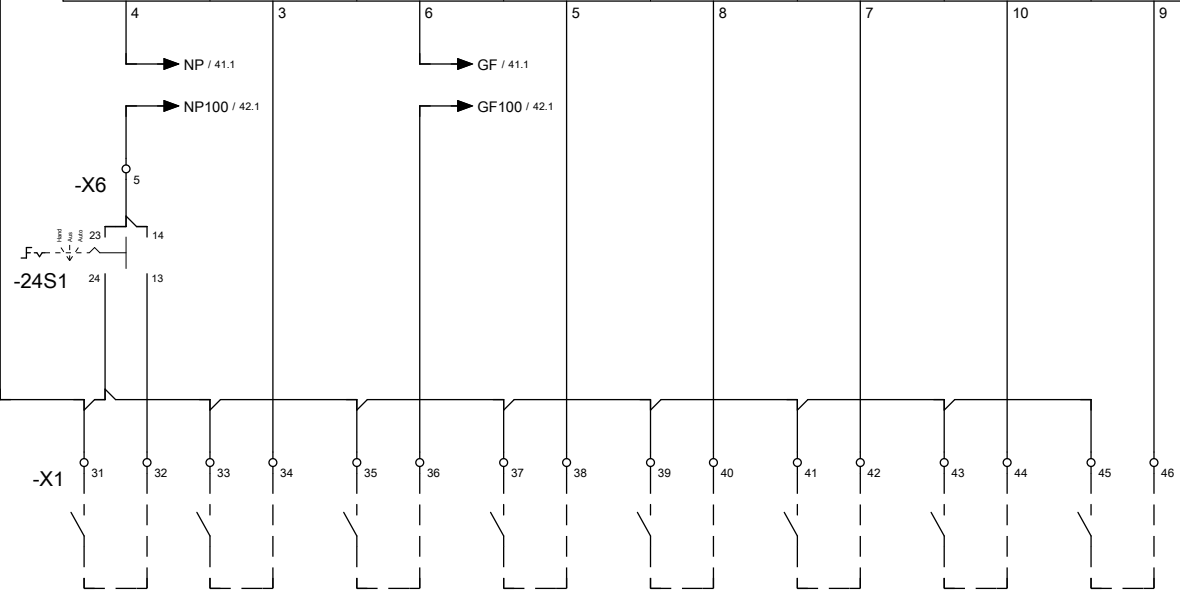
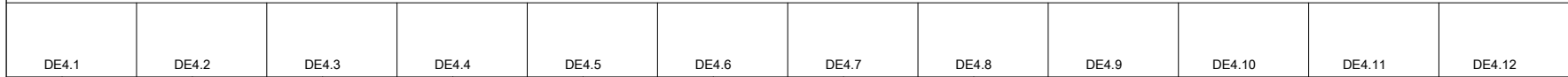
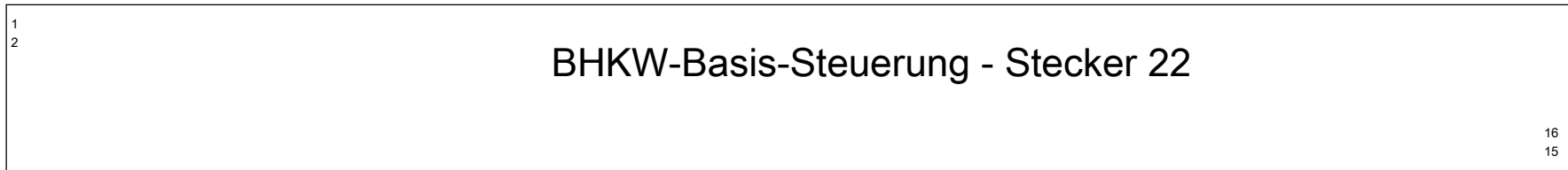

- Externe Anwahl Netzparallelbetrieb
100% Leistung (Wärme)
- Externe Anwahl Netzersatzbetrieb
- Externe Anwahl Gleitende Fahrweise
50-100% Leistung (Strom)
- Umschaltung Gas A/B
- Externe Störung 1
Abgas-STB
- Externe Störung 2
- Externe Störung 3
- Externe Störung 4
- Reserve
- Reserve
- Reserve
- Reserve

A	-X6/5	7.4.14	Klaj	Datum	13.03.14	BHKW-Basis-Steuerung Stecker 22-DE4 Digitale Eingänge Schaltschrank	EM-6R3	VISSMANN Viessmann Kraft-Wärme-Kopplung GmbH 86899 Landsberg, Emmy-Noether-Str.3 Tel.08191/9279-0 Fax.9279-23	Vitobloc 200 EM-6/15 R3	Anlage	=
				Bearb.	Spensberger				Ort	+ 5840066 DE	
Zustand	Änderung	Datum	Name	Norm	BHKW				Urspr.	Ers. f.	Serien-Nr.
								Modul-Nr.		von	46

BHKW-Basis-Steuerung - Stecker 23

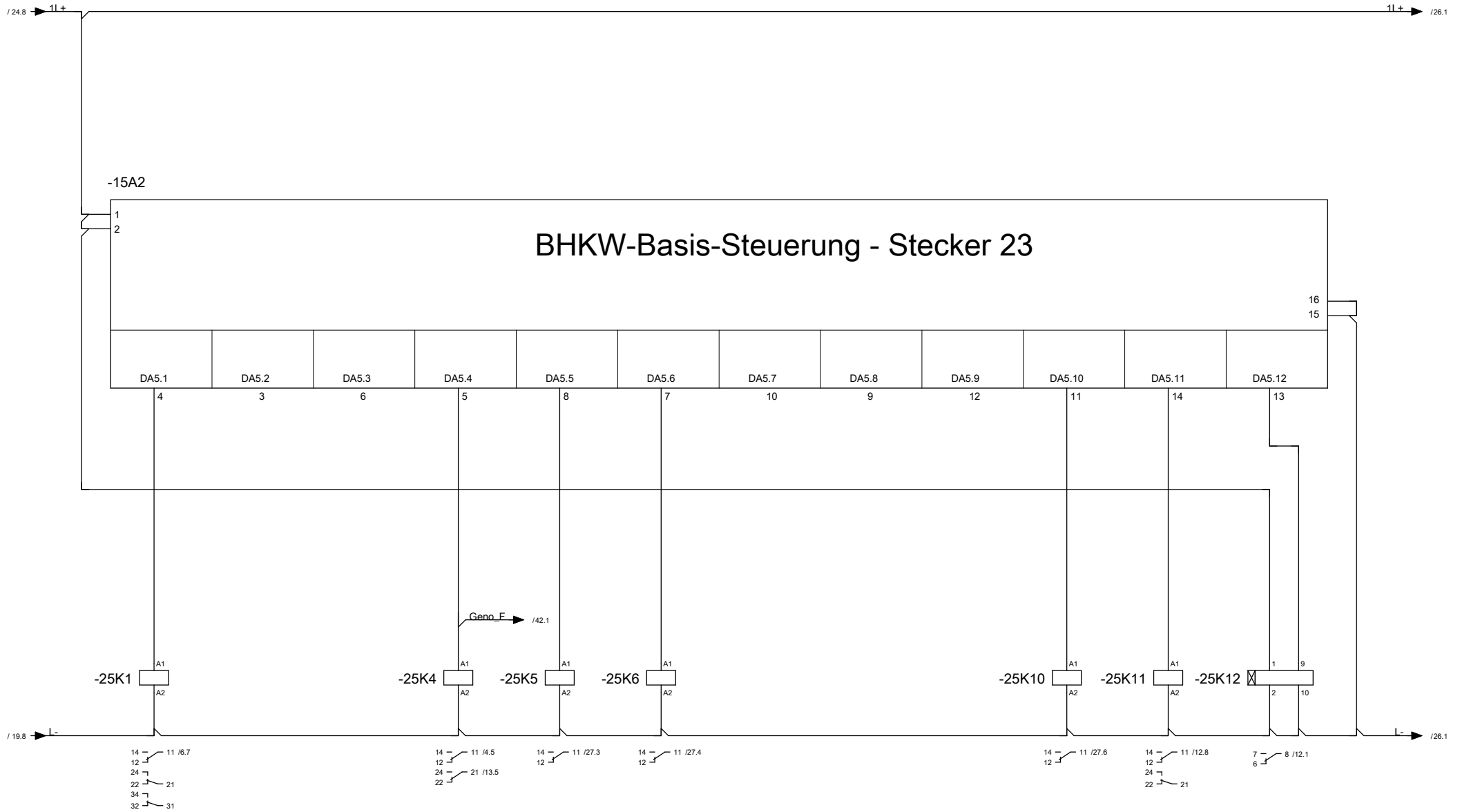

Anlasser EIN Drehzahl Zündung Freigabe Geno Bereit Betrieb Sammelstörung Abschaltung Einspeiseschalter Watchdog

B	23.05.14	Klaj	Datum	13.03.14	BHKW-Basis-Steuerung Stecker 23-DA2 Digitale Ausgänge Schaltschrank	EM-6R3	 Viessmann Kraft-Wärme-Kopplung GmbH 86899 Landsberg, Emmy-Noether-Str.3 Tel.08191/9279-0 Fax.9279-23	Vitobloc 200 EM-6/15 R3	Anlage	=	
a	09.10.19	Pfip	Bearb.	Spensberger				Ort	+ 5840066 DE		
			Gepr.	R.Schmid				Serien-Nr.		Blatt	25
Zustand	Änderung	Datum	Name	Norm	BHKW	Urspr.	Ers. f.	Modul-Nr.		von	46

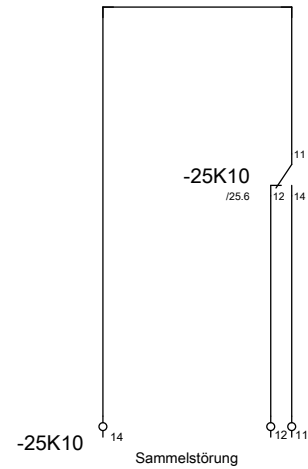
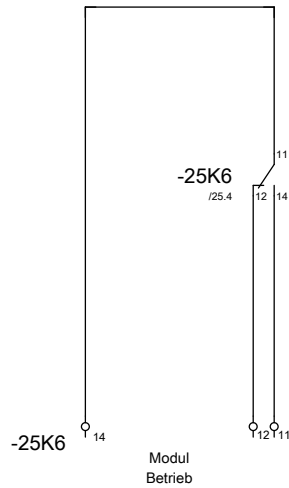
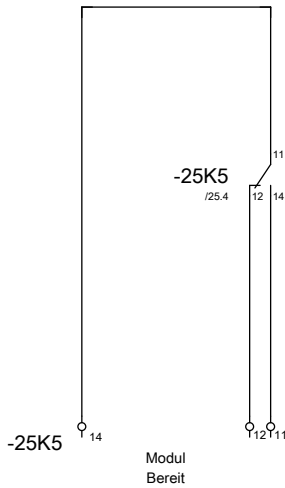

Potentialfreie Klemmenrelais-Kontakte zur bauseitigen Verwendung

	B	23.05.14	Klaj	Datum	13.03.14	Potentialfreie Klemmenrelais-Kontakte		EM-6R3	 Viessmann Kraft-Wärme-Kopplung GmbH 86899 Landsberg, Emmy-Noether-Str.3 Tel.08191/9279-0 Fax.9279-23	Anlage =	
				Bearb.	Spensberger					Ort = + 5840066 DE	
				Gepr.	R.Schmid					Serien-Nr. Blatt 27	
Zustand	Änderung	Datum	Name	Norm	BHKW	Urspr.	Ers. f.				Modul-Nr. von 46



Potentialfreie Kontakte zur bauseitigen Verwendung

				Datum	13.03.14	Potentialfreie Kontakte		EM-6R3		Vitobloc 200 EM-6/15 R3		Anlage	=
				Bearb.	Spensberger						Ort	+ 5840066 DE	
				Gepr.	R.Schmid					Serien-Nr.		Blatt	28
Zustand	Änderung	Datum	Name	Norm	BHKW	Urspr.	Ers. f.			Modul-Nr.		von	46

Viessmann Kraft-Wärme-Kopplung GmbH
 86899 Landsberg, Emmy-Noether-Str.3
 Tel.08191/9279-0 Fax.9279-23

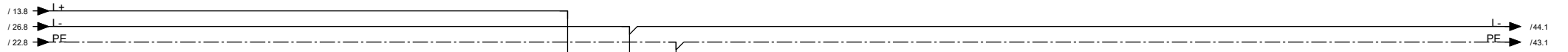

/15.8 CAN_R
von LON 3000

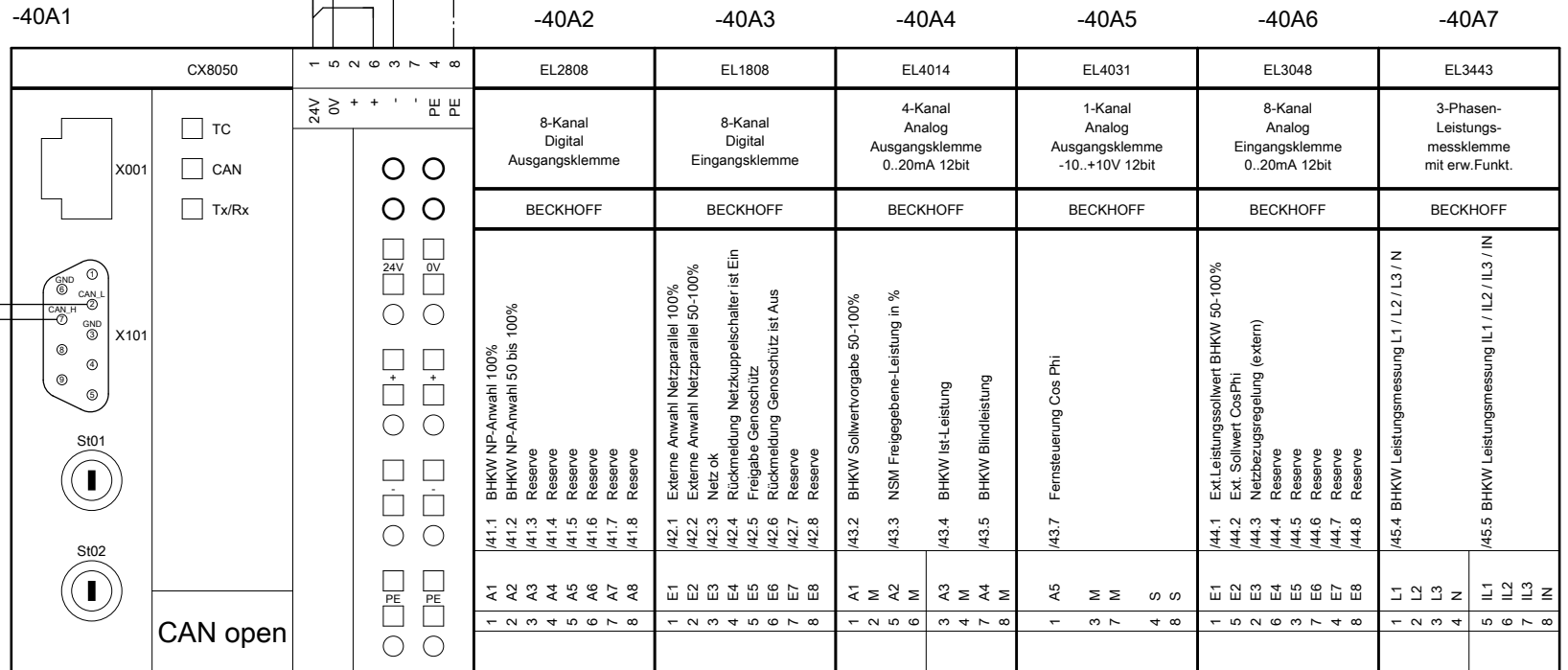

a	Kondensator entf.	09.10.19	Pfip	Datum	08.02.2019
				Bearb.	SpnB
				Gepr.	SmTo
Zustand	Änderung	Datum	Name	Norm	BHKW
				Urspr.	Ers. f.

Übersicht Retrofit		EM-6R3
--------------------	--	--------

VISSMANN
Viessmann Kraft-Wärme-Kopplung GmbH
86899 Landsberg, Emmy-Noether-Str.3
Tel.08191/9279-0 Fax.9279-23

Vitobloc 200 EM-6/15 R3		Anlage	=
		Ort	+ 5840066 DE
Serien-Nr.		Blatt	40
Modul-Nr.		von	46

-40A2		-40A2		-40A2		-40A2		-40A2		-40A2		-40A2		-40A2																									
Digital Ausgang EL2808		Digital Ausgang EL2808		Digital Ausgang EL2808		Digital Ausgang EL2808		Digital Ausgang EL2808		Digital Ausgang EL2808		Digital Ausgang EL2808		Digital Ausgang EL2808																									
BHKW NP-Anwahl 100%		BHKW NP-Anwahl 50 bis 100%		Reserve		Reserve		Reserve		Reserve		Reserve		Reserve																									
A1	○	0V	○	/40.4	A2	○	0V	○	/40.4	A3	○	0V	○	/40.4	A4	○	0V	○	/40.4	A5	○	0V	○	/40.4	A6	○	0V	○	/40.5	A7	○	0V	○	/40.5	A8	○	0V	○	/40.5
1	9	2	10		3	11	4	12		5	13	6	14		7	15	8	16																					



Anwahl BHKW
Netzparallelbetrieb
100%

Anwahl BHKW
Netzparallelbetrieb
50-100%

Reserve

Reserve

Reserve

Reserve

Reserve

Reserve

				Datum 08.02.2019						Anlage =			
				Bearb. SpnB		Digitale Ausgänge A1-A8		EM-6R3		Viessmann Kraft-Wärme-Kopplung GmbH		Ort + 5840066 DE	
				Gepr. SmTo						Serien-Nr.		Blatt 41	
Zustand		Änderung		Datum		Name		Norm BHKW		Urspr.		Ers. f.	
										86899 Landsberg, Emmy-Noether-Str.3		von 46	
										Tel.08191/9279-0 Fax.9279-23			

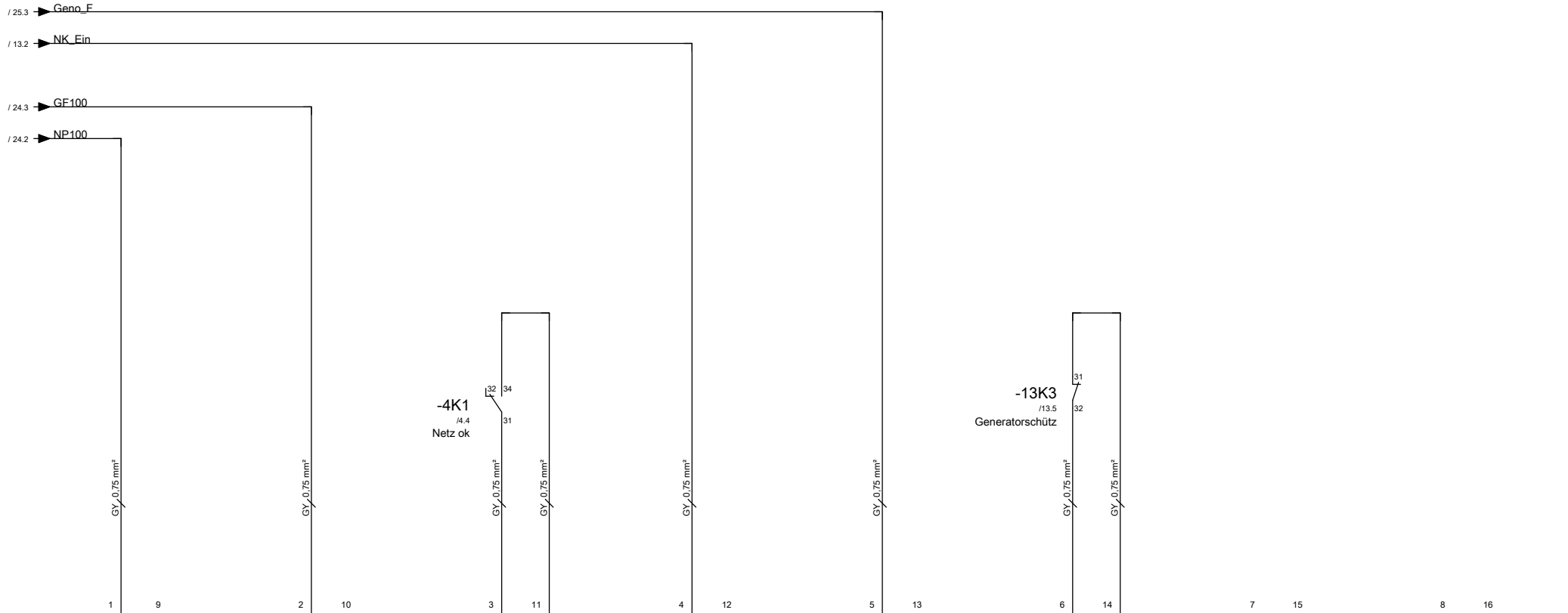

E1	24V	/40.5	E2	24V	/40.5	E3	24V	/40.5	E4	24V	/40.5	E5	24V	/40.5	E6	24V	/40.5	E7	24V	/40.5	E8	24V	/40.5
Externe Anwahl Netzparallel 100%			Externe Anwahl Netzparallel 50-100%			Netz ok			Rückmeldung Netzkuppelschalter ist Ein			Freigabe Genoschutz			Rückmeldung Genoschutz ist Aus			Reserve			Reserve		
EL 1808 Digital Eingang			EL 1808 Digital Eingang			EL 1808 Digital Eingang			EL 1808 Digital Eingang			EL 1808 Digital Eingang			EL 1808 Digital Eingang			EL 1808 Digital Eingang			EL 1808 Digital Eingang		

-40A3 -40A3 -40A3 -40A3 -40A3 -40A3 -40A3 -40A3

Externe Anwahl
Netzparallel 100% Externe Anwahl
Netzparallel 50-100% Netz ok Rückmeldung
Netzkuppelschalter ist Ein Freigabe
Genoschutz Rückmeldung
Genoschutz ist Aus Reserve Reserve

a	E3, E4, E5	09.10.19	Pfp	Datum	08.02.2019	Digitale Eingänge E1-E8	EM-6R3	VIESMANN Viessmann Kraft-Wärme-Kopplung GmbH 86899 Landsberg, Emmy-Noether-Str.3 Tel.08191/9279-0 Fax.9279-23	Vitobloc 200 EM-6/15 R3		Anlage	=
				Bearb.	SpnB				Ort	+ 5840066 DE		
				Gepr.	SmTo				Serien-Nr.		Blatt	42
Zustand	Änderung	Datum	Name	Norm	BHKW	Urspr.	Ers. f.	Modul-Nr.		von	46	

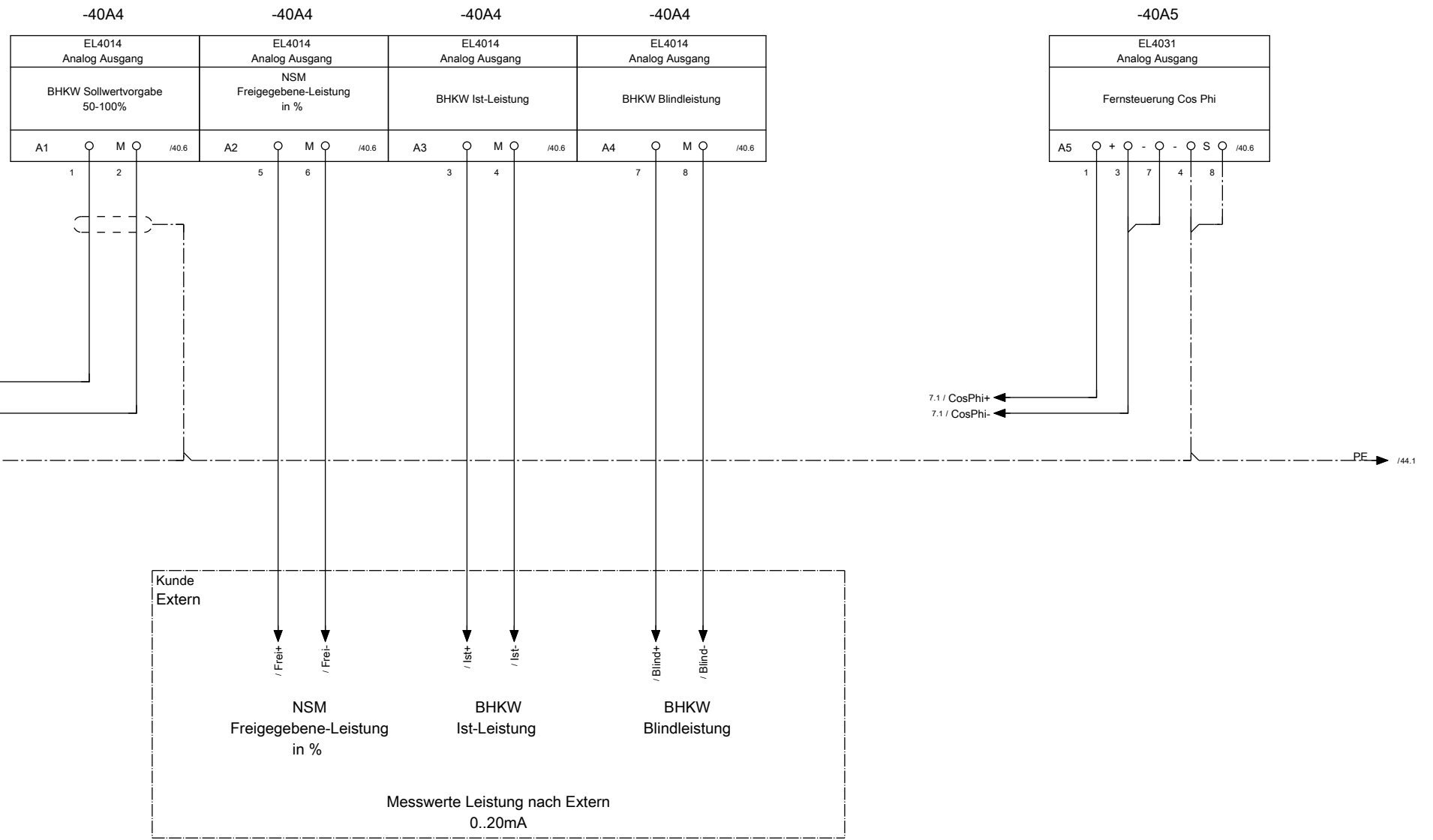

		Datum	08.02.2019						Anlage	=	
		Bearb.	SpnB		Analoge Ausgänge A1-A5		EM-6R3		Ort	+ 5840066 DE	
		Gepr.	SmTo						Serien-Nr.		Blatt
Zustand	Änderung	Datum	Name	Norm	BHKW	Urspr.	Ers. f.	Viessmann Kraft-Wärme-Kopplung GmbH 86899 Landsberg, Emmy-Noether-Str.3 Tel.08191/9279-0 Fax.9279-23		Modul-Nr.	von
										43	
										46	

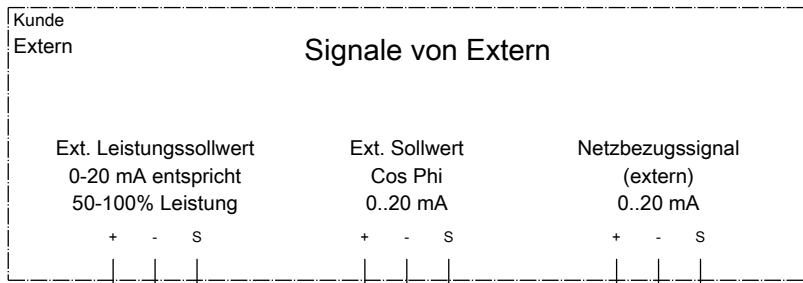

1	5	2	6	3	7	4	8
E1	E2	E3	E4	E5	E6	E7	E8
/40.7	/40.7	/40.7	/40.7	/40.7	/40.7	/40.7	/40.7
Ext. Leistungssollwert BHKW 50-100%	Ext. Sollwert CosPhi	Netzbezugsregelung (extern)	Reserve	Reserve	Reserve	Reserve	Reserve
EL3048 Analog Eingang	EL3048 Analog Eingang	EL3048 Analog Eingang	EL3048 Analog Eingang	EL3048 Analog Eingang	EL3048 Analog Eingang	EL3048 Analog Eingang	EL3048 Analog Eingang
-40A6	-40A6	-40A6	-40A6	-40A6	-40A6	-40A6	-40A6

Externer Sollwert
 Gleitende Fahrweise
 0..20 mA = 50..100%
 Leistung
 (nur in Verbindung
 mit Anwahl Strom
 wirksam)

Ext. Sollwert
 Cos Phi
 0..20 mA

Netzbezugsignal
 (extern)
 0..20 mA

						Analoge Eingänge E1-E8		EM-6R3		VIESMANN Viessmann Kraft-Wärme-Kopplung GmbH 86899 Landsberg, Emmy-Noether-Str.3 Tel.08191/9279-0 Fax.9279-23		Vitobloc 200 EM-6/15 R3 Anlage = Ort + 5840066 DE		Serien-Nr. Modul-Nr.		Blatt 44 von 46	
Zustand	Änderung	Datum	Name	Norm	BHKW	Urspr.	Ers. f.										

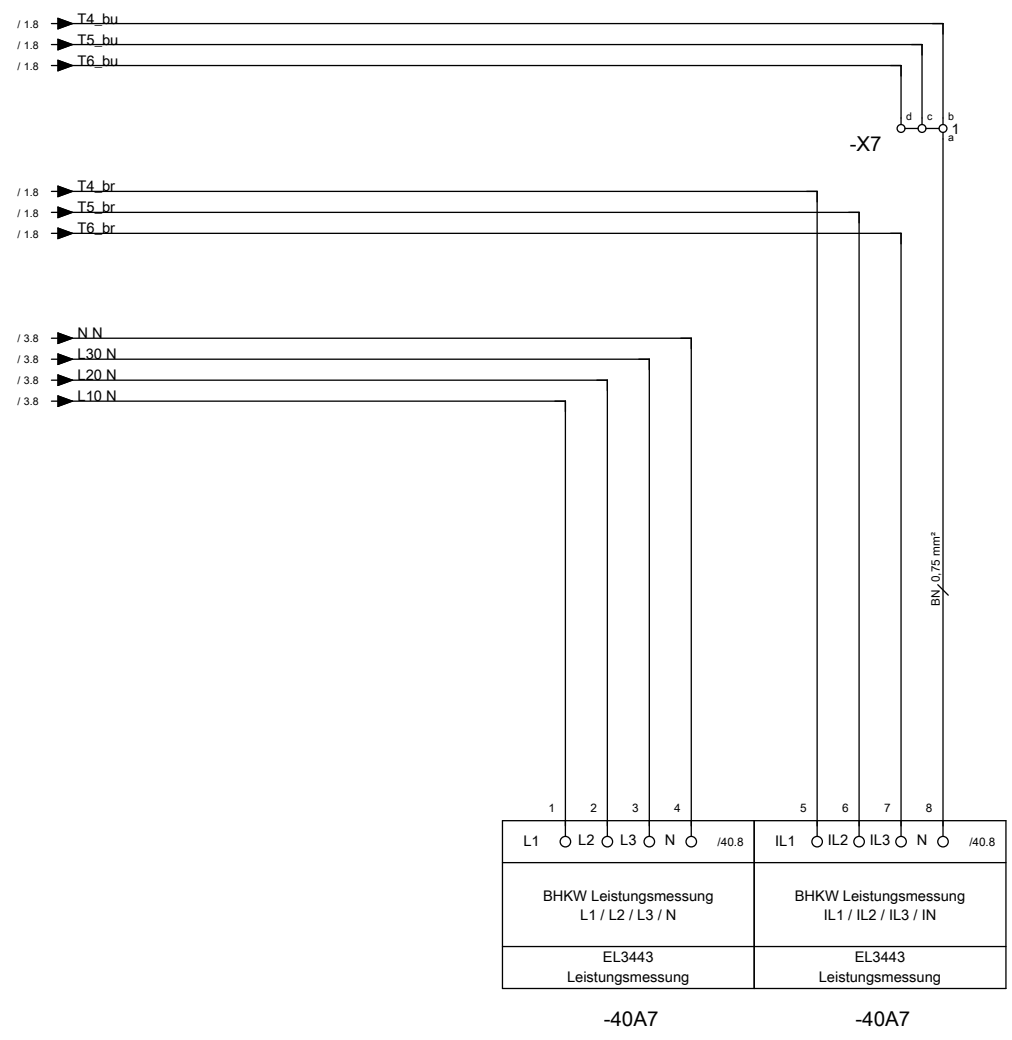

a	Strommessung	09.10.19	Pfip	Datum	08.02.2019	3-Phasen-Leistungsmessung	EM-6R3	VIEMANN Viessmann Kraft-Wärme-Kopplung GmbH 86899 Landsberg, Emmy-Noether-Str.3 Tel.08191/9279-0 Fax.9279-23	Vitobloc 200 EM-6/15 R3	Anlage	=	
				Bearb.	SpnB					Ort	+ 5840066 DE	
				Gepr.	SmTo					Serien-Nr.		Blatt
Zustand	Änderung	Datum	Name	Norm	BHKW	Urspr.	Ers. f.		Modul-Nr.		von	46

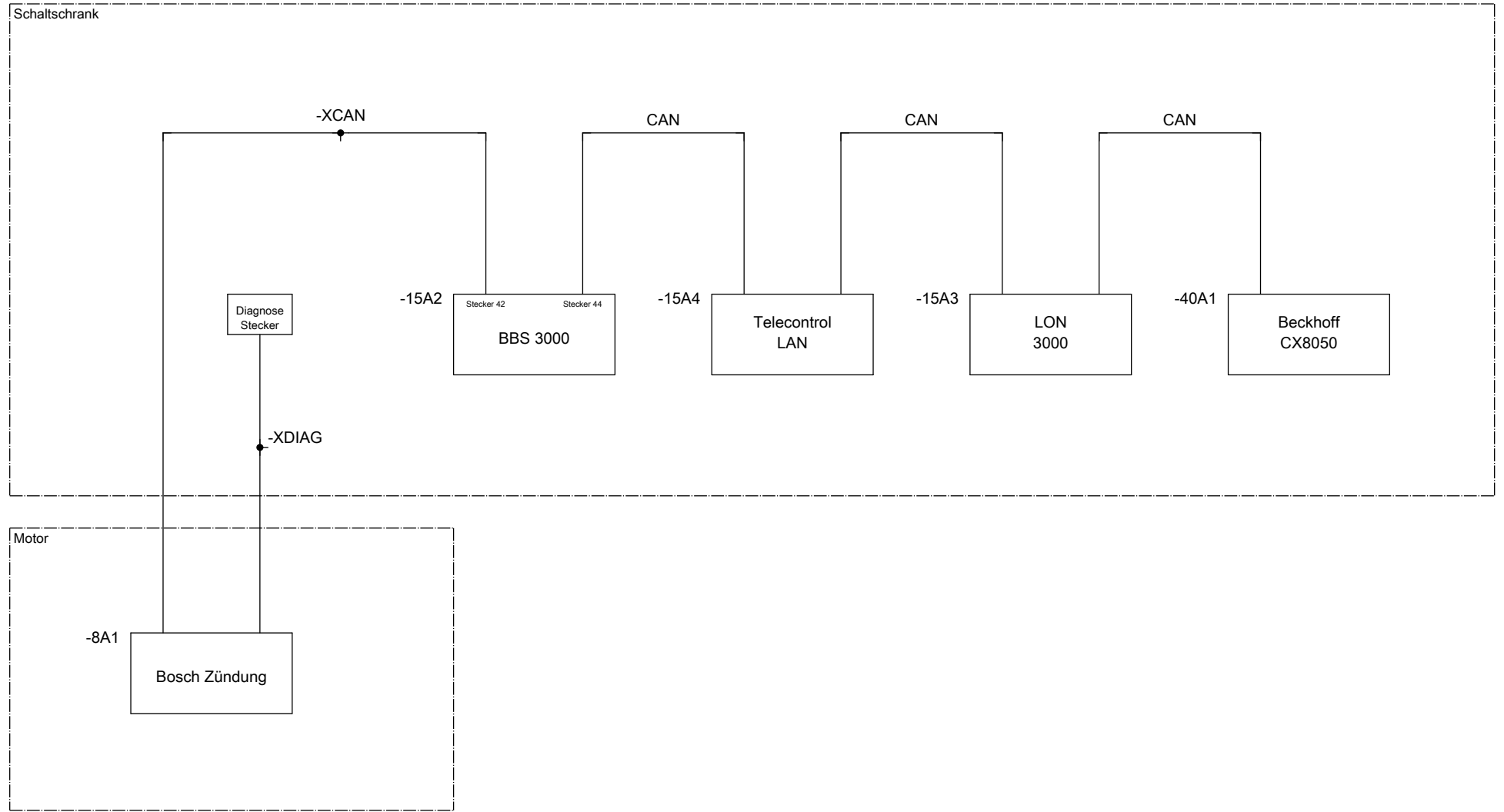

					Datum	08.02.2019		Übersicht CAN-Bus		EM-6R3	 Viessmann Kraft-Wärme-Kopplung GmbH 86899 Landsberg, Emmy-Noether-Str.3 Tel.08191/9279-0 Fax.9279-23	Vitobloc 200 EM-6/15 R3		Anlage	=
					Bearb.	SpmB						Ort	+ 5840066 DE		
					Gepr.	SmiR						Serien-Nr.			Blatt
Zustand	Änderung	Datum	Name	Norm	BHKW	Urspr.	Ers. f.			Modul-Nr.			von	46	

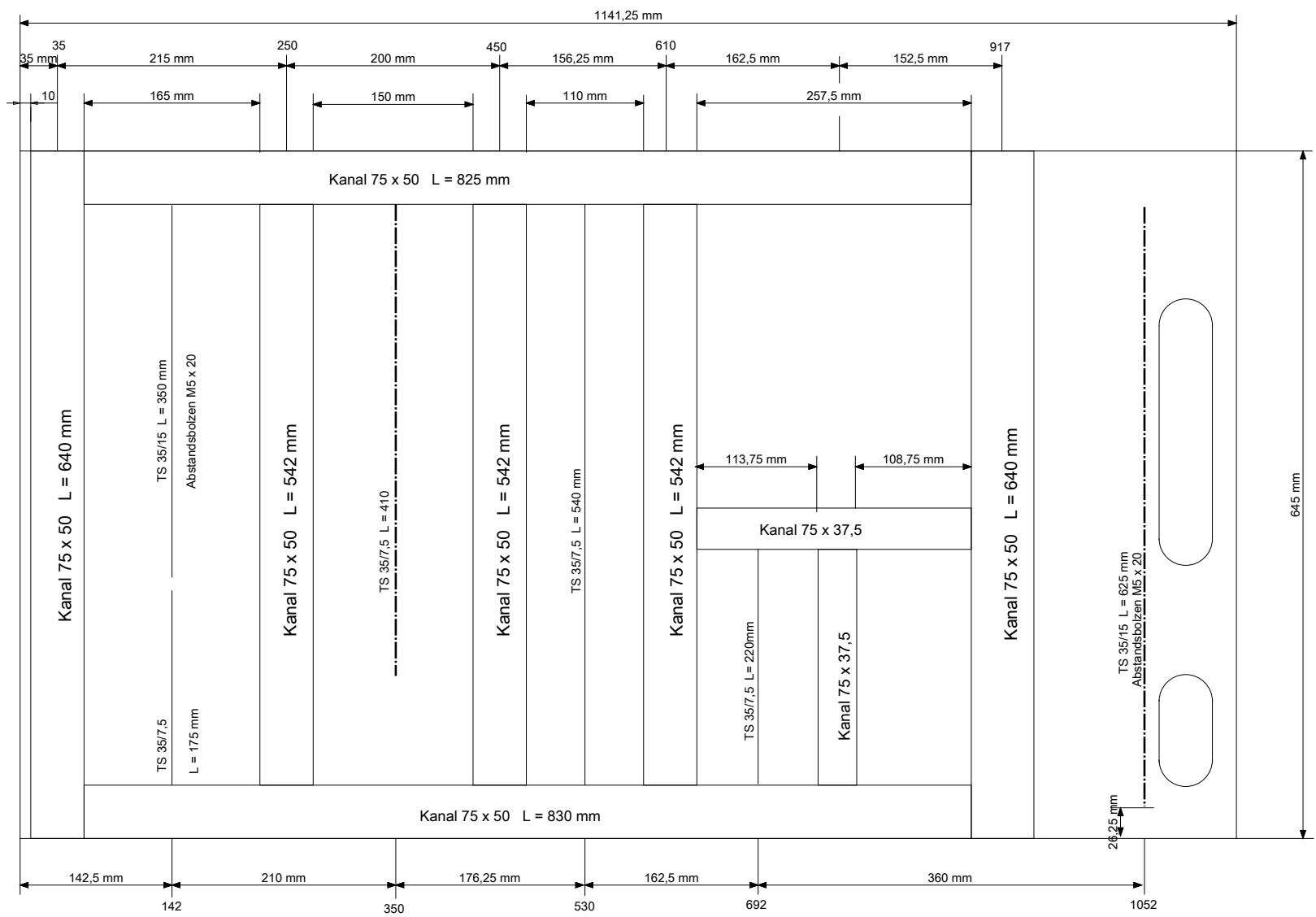

				Datum 08.02.2019		Aufbau, Montageplatte (Kanäle)		EM-6R3		 Viessmann Kraft-Wärme-Kopplung GmbH 86899 Landsberg, Emmy-Noether-Str.3 Tel.08191/9279-0 Fax.9279-23		Anlage = BHKW	
				Bearb. SpnB								Ort + 5840066 DE	
				Gepr.									
Zustand	Änderung	Datum	Name	Norm	BHKW	Urspr.	Ers. f.			Serien-Nr.		Blatt 30	
										Modul-Nr.		von 31	

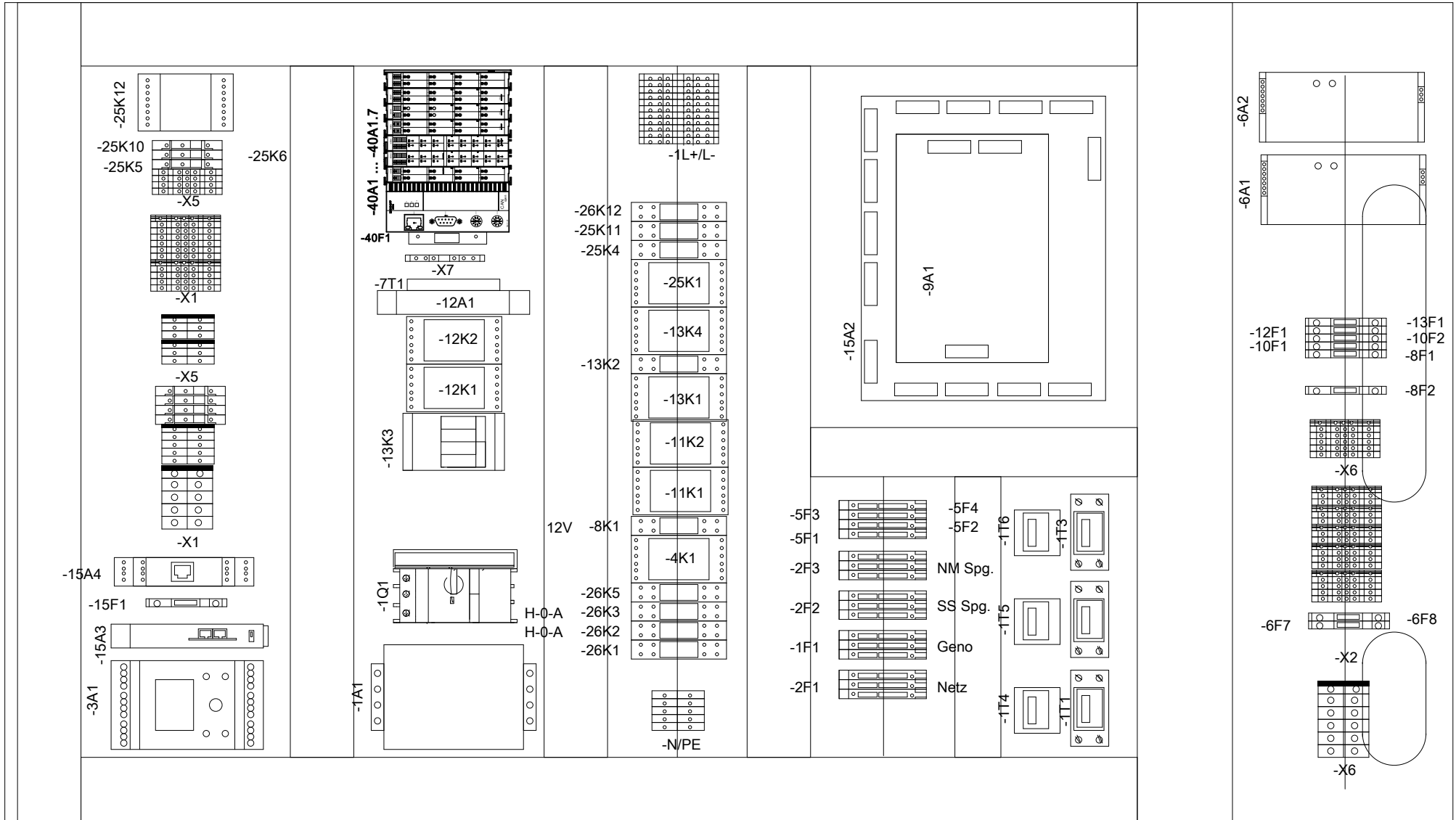

				Datum 08.02.2019						Anlage = BHKW	
				Bearb. SpnB		Aufbau, Montageplatte		EM-6R3		Ort + 5840066 DE	
				Gepr.						Serien-Nr.	
Zustand	Änderung	Datum	Name	Norm	BHKW	Urspr.	Ers. f.			Modul-Nr.	
										Blatt 31	
										von 31	

VIEMANN
 Viessmann Kraft-Wärme-Kopplung GmbH
 86899 Landsberg, Emmy-Noether-Str.3
 Tel.08191/9279-0 Fax.9279-23

Vitobloc 200 EM-6/15 R3
 Serien-Nr.
 Modul-Nr.